

# *Grizzly* Industrial, Inc.®

## 2-IN-1 COMBINATION NAILER/STAPLER

MODEL H7664

## INSTRUCTION MANUAL



COPYRIGHT © JULY, 2005 BY GRIZZLY INDUSTRIAL, INC.

WARNING: NO PORTION OF THIS MANUAL MAY BE REPRODUCED IN ANY SHAPE OR FORM WITHOUT THE WRITTEN APPROVAL OF GRIZZLY INDUSTRIAL, INC.

#BL7293 PRINTED IN CHINA



# **WARNING!**

**Some dust created by power sanding, sawing, grinding, drilling, and other construction activities contains chemicals known to the State of California to cause cancer, birth defects or other reproductive harm. Some examples of these chemical are:**

- **Lead from lead-based paints.**
- **Crystalline silica from bricks, cement and other masonry products.**
- **Arsenic and chromium from chemically-treated lumber.**

**Your risk from these exposures varies, depending on how often you do this type of work. To reduce your exposure to these chemicals: Work in a well ventilated area, and work with approved safety equipment, such as those dust masks that are specially designed to filter out microscopic particles.**

# Table of Contents

<b>SECTION 1: SAFETY</b> .....	<b>4</b>
Safety Instructions For Pneumatic Tools.....	4
Additional Safety Instructions for Nailers and Staplers .....	6
<b>SECTION 2: INTRODUCTION</b> .....	<b>8</b>
Foreword.....	8
Tool Data .....	8
Contact Info .....	8
<b>SECTION 3: SET UP</b> .....	<b>9</b>
Unpacking.....	9
Inventory .....	9
Compressed Air System .....	10
Safety Yoke .....	11
<b>SECTION 4: OPERATIONS</b> .....	<b>12</b>
Loading .....	12
Operating.....	12
Adjusting Depth .....	13
Single/Bump Fire Operation .....	14
Clearing Jammed Nails/Staples .....	14
Replacing Pistons/O-Rings.....	15
<b>SECTION 5: MAINTENANCE</b> .....	<b>17</b>
Cleaning.....	17
Lubricating .....	17
Troubleshooting .....	18
H7664 Parts Breakdown .....	19
H7664 Parts List .....	20
<b>WARRANTY AND RETURNS</b> .....	<b>21</b>

# SECTION 1: SAFETY

## **WARNING**

### **For Your Own Safety Read Instruction Manual Before Operating This Equipment**

The purpose of safety symbols is to attract your attention to possible hazardous conditions. This manual uses a series of symbols and signal words which are intended to convey the level of importance of the safety messages. The progression of symbols is described below. Remember that safety messages by themselves do not eliminate danger and are not a substitute for proper accident prevention measures.



Indicates an imminently hazardous situation which, if not avoided, WILL result in death or serious injury.



Indicates a potentially hazardous situation which, if not avoided, COULD result in death or serious injury.



Indicates a potentially hazardous situation which, if not avoided, MAY result in minor or moderate injury. It may also be used to alert against unsafe practices.

**NOTICE**

This symbol is used to alert the user to useful information about proper operation of the equipment.

## **WARNING**

### **Safety Instructions For Pneumatic Tools**

- 1. KEEP ALL SAFETY DEVICES IN PLACE** and in working order.
- 2. REMOVE ADJUSTING KEYS AND WRENCHES.** Form habit of checking to see that keys and adjusting wrenches are removed from tool before operation.
- 3. KEEP WORK AREA CLEAN.** Cluttered areas and benches invite accidents.
- 4. DO NOT USE IN DANGEROUS ENVIRONMENT.** Do not use pneumatic tools in damp or wet locations, or where any flammable or noxious fumes may exist. Keep work area well lighted.
- 5. KEEP CHILDREN AND VISITORS AWAY.** All children and visitors should be kept at a safe distance from work area.
- 6. MAKE WORKSHOP CHILD PROOF** by locking your shop and shutting off air valves.
- 7. DO NOT FORCE TOOL.** It will do the job better and safer at the rate for which it was designed.
- 8. USE THE RIGHT TOOL.** Do not force tool or attachment to do a job for which it was not designed.
- 9. DO NOT USE UNDER THE INFLUENCE OF DRUGS OR ALCOHOL.**

# **WARNING**

## **Safety Instructions For Pneumatic Tools**

10. **USE PROPER AIR HOSE** for the tool. Make sure your air hose is in good condition and is long enough to reach your work without stretching.
11. **WEAR PROPER APPAREL.** Do not wear loose clothing, gloves, neckties, rings, bracelets, or other jewelry which may get caught in moving parts. Non-slip footwear is recommended. Wear a protective hair covering to contain long hair.
12. **ALWAYS USE SAFETY GLASSES.** Also use a face or dust mask if cutting operation is dusty. Everyday eyeglasses only have impact resistant lenses, they are NOT safety glasses.
13. **WEAR APPROVED HEARING PROTECTION.**
14. **SECURE WORK.** Use clamps or a vise to hold work when practical. It is safer than using your hand and frees both hands to operate tool.
15. **DO NOT OVERREACH.** Keep proper footing and balance at all times.
16. **MAINTAIN TOOLS WITH CARE.** Keep tools lubricated and clean for best and safest performance. Follow instructions for lubricating and changing accessories.
17. **REDUCE THE RISK OF UNINTENTIONAL STARTING.** Do not carry tool with hand on trigger and always disconnect from air when not in use.
18. **DISCONNECT TOOLS** before servicing and changing accessories.
19. **USE THE RECOMMENDED ACCESSORIES.** Consult the owner's manual for recommended accessories. The use of improper accessories may cause risk of injury.
20. **CHECK DAMAGED PARTS.** Before further use of the tool, a guard or other part that is damaged should be carefully checked to determine that it will operate properly and perform its intended function. Check for alignment of moving parts, binding of moving parts, breakage of parts, mounting, and any other conditions that may affect its operation. A guard or other part that is damaged should be properly repaired or replaced.
21. **NEVER LEAVE UNATTENDED TOOL CONNECTED TO AIR.** Disconnect the air hose and do not leave tool until it is relieved of any built up pressure.
22. **NEVER ALLOW UNTRAINED USERS TO USE THIS TOOL WHILE UNSUPERVISED.**
23. **IF YOU ARE UNSURE OF THE INTENDED OPERATION, STOP USING THE TOOL.** Seek formal training or research books or magazines that specialize in pneumatic tools.

# **WARNING**

## **Additional Safety Instructions for Nailers and Staplers**

- 1. HAND INJURIES:** Do not place your hands near the nail/staple point of entry. A nail/staple can deflect and tear through the surface of the workpiece, puncturing your hand or fingers.
- 2. COMBUSTIBLE GASES:** Never connect the nailer/stapler to pressurized oxygen or other combustible gases as a power source. Only use filtered, lubricated, and regulated compressed air.
- 3. SAFE HANDLING:** Never point the nailer/stapler at others! Do not keep the trigger pulled when loading fasteners, carrying, or holding tool. Carry the nailer/stapler only by the handle, never by any other part. Do not carry the nailer/stapler by the air hose. Disconnect the nailer/stapler from the air hose when going up and down ladders.
- 4. CLEANING:** Never use gasoline or other flammable liquids to clean the nailer/stapler; vapors in the nailer/stapler will ignite by a spark and cause it to explode.
- 5. HOSE USAGE:** Make sure your air hose is designed for the tool in use, is in good condition, and is long enough to reach your work without stretching. However, an overly long air hose in the work area may be a tripping hazard.
- 6. OPERATING QUESTIONS:** If you are not sure about the intended operation, stop using the nailer/stapler. Seek formal training or research books or magazines that specialize in pneumatic tools.
- 7. MAINTENANCE:** Always disconnect air from the nailer/stapler when servicing or installing nails or staples. During maintenance, a nailer/stapler connected to air may fire accidentally, causing serious personal injury.
- 8. COMPRESSED AIR RATING:** Do not connect the nailer/stapler to compressed air that exceeds 120 PSI.
- 9. CHECK VALVE:** Do not use a check valve or any other fitting that allows air to remain in the tool.

## **⚠️ WARNING**

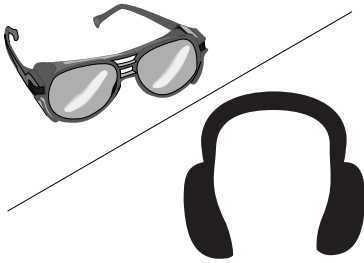

Operating this nailer/stapler can propel objects into the air, causing immediate eye damage. To protect yourself, always wear American National Standards Institute (ANSI) approved safety glasses or goggles when operating this equipment. In addition, this nailer/stapler discharges at 82 decibels. To protect your hearing, always wear ANSI approved ear protection when operating this nailer/stapler.

## **⚠️ WARNING**

Never point this nailer/stapler at yourself or another person! Always pay attention to the direction this nailer/stapler is pointed. Use this tool with respect and caution to lessen the possibility of operator or bystander injury. Ignoring this warning may result in serious personal injury.

## **⚠️ CAUTION**

No list of safety guidelines can be complete. Every shop environment is different. Always consider safety first, as it applies to your individual working conditions. Use this and other tools with caution and respect. Failure to do so could result in serious personal injury, damage to equipment or poor work results.

# SECTION 2: INTRODUCTION

## Foreword

We are proud to offer the Grizzly Model H7664 2-in-1 Combination Nailer/Stapler. This model is part of a growing Grizzly family of fine pneumatic tools. When used according to the guidelines set forth in this manual, you can expect years of trouble-free, enjoyable operation and proof of Grizzly's commitment to customer satisfaction.

The Model H7664 features a 360° exhaust port, comfort grip rubber handle, and economical air consumption with low noise. The Model H7664 can shoot  $\frac{5}{8}$ "-2", 18 Gauge brad nails and 18 Gauge  $\frac{5}{8}$ "-1 $\frac{5}{8}$ ",  $\frac{1}{4}$ " crown staples.

The specifications, details, and photographs in this manual represent the Model H7664 as supplied when the manual was prepared. However, owing to Grizzly's policy of continuous improvement, changes may be made at any time with no obligation on the part of Grizzly.

## Tool Data

Brad Length .....  $\frac{5}{8}$ "-2" (18 Gauge)  
Staple Length .....  $\frac{5}{8}$ "-1 $\frac{5}{8}$ "  
Staple Crown .....  $\frac{1}{4}$ " (18 Gauge)  
Magazine Capacity ..... 100 pieces  
Air Inlet .....  $\frac{1}{4}$ " NPT  
Weight ..... 3.3 lbs.  
Operating Pressure ..... 60-100 PSI

## Contact Info

If you have any comments regarding this manual, please write to us at the following address:

Grizzly Industrial, Inc.  
C/O Technical Documentation Manager  
P.O. Box 2069  
Bellingham, WA 98227-2069

Most importantly, we stand behind our tools. If you have any service questions or parts requests, please call or write us at the location listed below.

Grizzly Industrial, Inc.  
1203 Lycoming Mall Circle  
Muncy, PA 17756  
Phone: (570) 546-9663  
Fax: (800) 438-5901  
E-Mail: [techsupport@grizzly.com](mailto:techsupport@grizzly.com)  
Web Site: <http://www.grizzly.com>

**! WARNING**

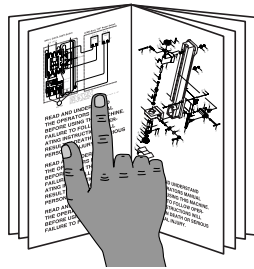

**Read the manual before operation. Become familiar with this nailer/stapler, its safety instructions, and its operation before beginning any work. Serious personal injury may result if safety or operational information is not understood or followed.**



# SECTION 3: SET UP

## Unpacking

Your Model H7664 left our warehouse in a carefully packed box. If you discover the nailer/stapler is damaged after you have signed for delivery, *please immediately call Customer Service at (570) 546-9663 for advice.*

Save the containers and all packing materials for possible inspection by the carrier or its agent. *Otherwise, filing a freight claim can be difficult.*

When you are completely satisfied with the condition of the shipment, you should inventory the equipment.

## Inventory

After you open the nailer/stapler box, you should find the following.

### Model H7664 Inventory (Figure 1)

A.	2-in-1 Nailer/Stapler .....	1
B.	Safety Goggles .....	1
C.	Pneumatic Tool Oil .....	1
D.	Hex Wrench 3mm .....	1
E.	Hex Wrench 4mm .....	1
F.	1¼" Brad Nail Sticks .....	2
G.	¾" Staple Sticks .....	2
H.	Carrying Case .....	1

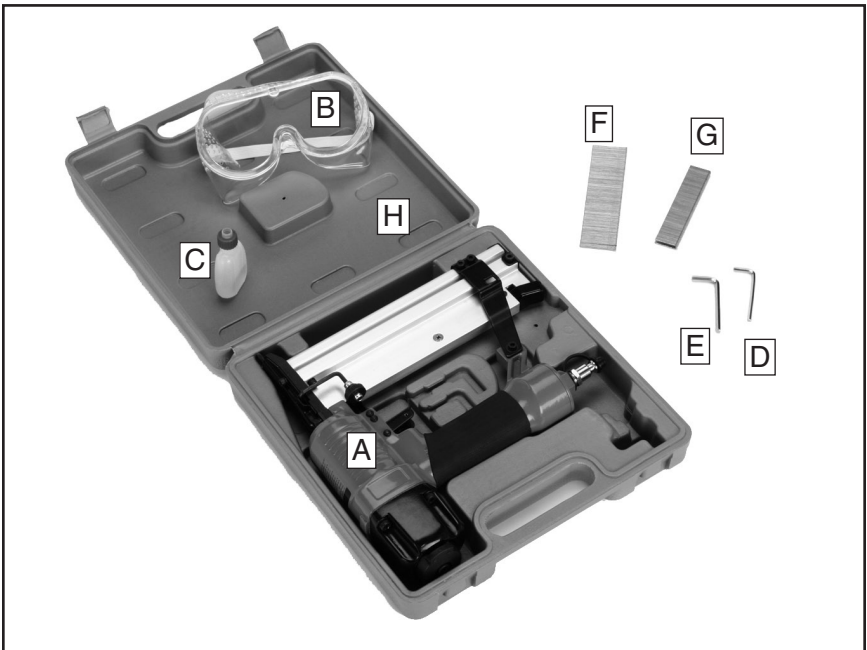

Figure 1. Model H7664 inventory.

## Compressed Air System

The Model H7664 is designed to be operated at 60-100 PSI using clean, dry, regulated, compressed air. **DO NOT exceed the 120 PSI maximum operating pressure for your model.**

Before using your new nailer/stapler, regulate the air pressure on your air compressor to the minimum PSI for your model.

An in-line filter/lubricator/regulator unit, depicted in **Figure 2**, can be installed and should be located as close to the nailer/stapler as possible.

This filter/lubricator/regulator unit will protect your tool from damaging water build-up, allow you to adjust and maintain constant air pressure to your tool, and save you the inconvenience of having to manually lubricate your tool every time you use it.

## ⚠ WARNING

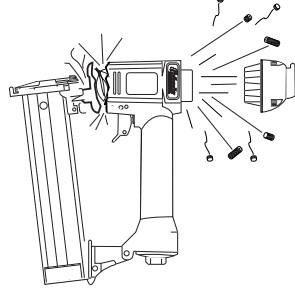

**Exceeding the maximum permissible operating pressure may cause the nailer/stapler to explode, blowing metal fragments in all directions. To protect yourself from serious personal injury, DO NOT allow your air compressor to exceed the recommended pressure when connected to this nailer/stapler!**

Check the current Grizzly catalog for availability of this unit. If you plan on installing a filter/lubricator/regulator unit in your compressed air system, always follow the connection instructions that come with the unit.

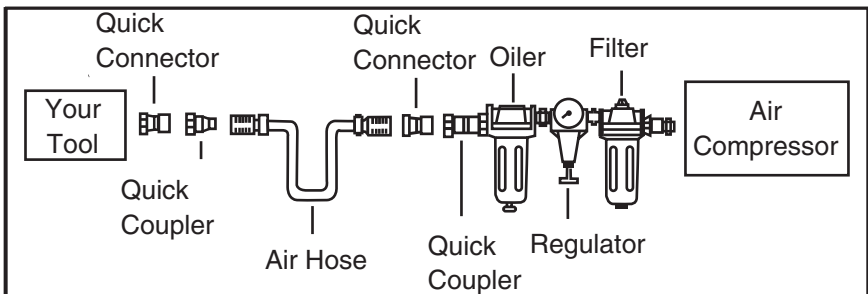

**Figure 2.** Typical filter/lubricator/regulator installation order.

# Safety Yoke

---

---

A safety yoke mechanism on the nose of the nailer/stapler acts as a safety device. When the trigger is pressed, the nailer/stapler will not fire until the safety yoke mechanism is depressed.

Before you use your nailer/stapler for the first time, check the safety yoke mechanism to ensure proper function. To do this:

1. **DISCONNECT NAILER/STAPLER FROM THE AIR SUPPLY!**
2. Make sure the magazine is empty and contains no nails/staples.
3. Make sure the trigger and the safety yoke mechanism move up and down without sticking.
4. Connect the nailer/stapler to the air supply.

## **WARNING**

The safety yoke is a mechanical device that can fail. Never rely on the safety yoke mechanism as an excuse to point the nailer/stapler at yourself or any bystanders. Serious injury may occur.

5. **Without pressing the trigger**, depress the safety yoke mechanism against a scrap piece of wood that is clean and free of any knots, nails, or other foreign objects.

- If the nailer/stapler does not fire, then the safety yoke mechanism is working correctly.
- If the stapler **does fire** when you do this, immediately disconnect the stapler from the air supply and call Grizzly Technical Support at (570) 546-9663 for help.
- If the stapler fires when the trigger is pulled, without the safety yoke mechanism being depressed, disconnect the stapler from the air supply and call Grizzly Technical Support at (570) 546-9663 for help.
- If the stapler is not working properly, check the lubrication of the sliding mechanisms of the safety yoke.

# SECTION 4: OPERATIONS

## Loading

When replacing brads or staples in your Model H7664, follow these guidelines:

Gauge: 18

Brad Length:  $\frac{5}{8}$ "-2"

Staple Length:  $\frac{5}{8}$ "-1 $\frac{5}{8}$ " (crown  $\frac{1}{4}$ " )

Capacity: 100

To load your nailer/stapler:

1. **DISCONNECT NAILER/STAPLER FROM THE AIR SUPPLY!**
2. Grip the nailer/stapler firmly, unlatch the catch lever (**Figure 3**), and pull the magazine pusher back completely.



**Figure 3.** Catch lever engaged and magazine pusher retracted.

3. Insert a strip of brads or staples, pointed-end down, into the magazine as shown in **Figure 4**.

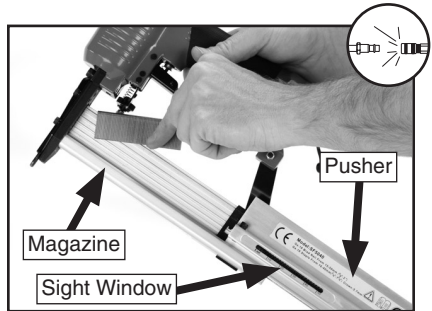

**Figure 4.** Loading nails into magazine.

4. Slide the staples or brads all the way down to the nose of the nailer/stapler.
5. Push the magazine toward the nose of the nailer/stapler until the catch lever locks.
6. Reload the nailer when the magazine sight window (**Figure 4**) shows the nail or staple level is low. The sight window shows up to approximately 50 nails or staples loaded.

## Operating

If you have not read the safety instructions in this manual, do not operate the nailer/stapler.

Before you operate your nailer/stapler, place two to three drops of the included oil into the quick connect fitting where the nailer/stapler connects to the air supply.

To operate your nailer/stapler:

1. Connect the air supply to the quick connect fitting.

2. To test for proper nail/staple penetration, hold the nailer/stapler perpendicular to the surface of a piece of clean scrap wood that is thick enough for the length of nails/staples you have loaded.
3. Depress the safety yoke mechanism on your workpiece.
4. Before pulling the trigger, make sure your free hand and other body parts are positioned out of the way of a potential path of a nail/staple in case of deflection.

Deflection is caused when grain irregularities, knots or foreign objects inside the wood cause the nail/staple to change its path, resulting in the nail/staple puncturing the surface of the workpiece, as shown in **Figure 5**.

Besides damaging your workpiece, deflection can cause injury if your free hand is securing the workpiece in the location that the nail/staple deflects.

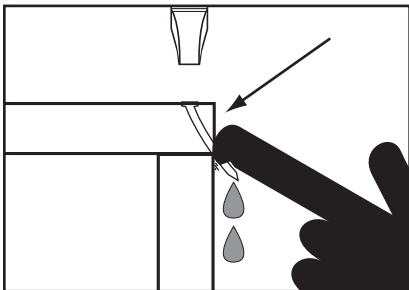

**Figure 5.** Example of nail deflection.

5. Pull the trigger.
  - If the nail/staple drove into the wood far enough, continue with your intended operations.
  - If the nail/staple either went too far or not far enough, then go to the **Adjusting Depth** sub-section on this page.

## Adjusting Depth

A depth adjustment knob is attached to the nose for setting the nail/staple depth.

**To adjust the depth:**

1. **DISCONNECT NAILER/STAPLER FROM THE AIR SUPPLY!**
2. Rotate the adjustment knob (**Figure 6**) clockwise to drive the nails/staples deeper or counterclockwise to drive the nails/staples shallower.

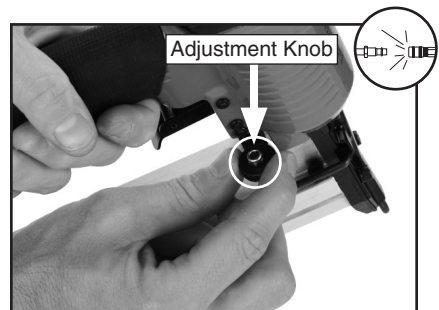

**Figure 6.** Rotating depth adjustment knob.

3. Connect nailer/stapler to the air supply and test the nail/staple depth, and repeat this entire procedure if necessary until the nail/staple depth is satisfactory.

## Single/Bump Fire Operation

---

---

The nailer/stapler is designed to fire one nail/staple at a time, or one after another, using the safety yoke mechanism. This is known as "bump fire".

### To operate your nailer/stapler in single fire mode:

1. Depress the safety yoke mechanism against the workpiece.
2. Pull the trigger, then remove your finger from the trigger after the nail/staple is driven.

### To operate your nailer/stapler in bump fire mode:

1. Pull the trigger.
2. Press the safety yoke mechanism against your workpiece and raise it after the nail/staple is driven.
3. Hold the trigger and repeat **Step 2** to drive more nails/staples.

## Clearing Jammed Nails/Staples

---

---

A jammed nail or staple must be cleared before using the nailer/stapler again.

### To clear a jammed nail or staple from the magazine:

1. **DISCONNECT THE NAILER/STAPLER FROM THE AIR SUPPLY!**
2. Unlock the catch lever and pull the magazine pusher back completely.
3. Locate and remove the jammed nail/staple with a pair of needle nose pliers.
4. Throw the damaged nail/staple away.
5. Inspect the nail/staple stick. If it is bent or damaged, throw it away and insert a new stick that only contains clean, undamaged nails/staples. **DO NOT** use dirty or damaged nails/staples!
6. Push the magazine pusher forward to the front of the magazine until the catch lever locks.

To clear a jammed nail from the discharge area:

1. **DISCONNECT NAILER/STAPLER FROM THE AIR SUPPLY!**
2. Unlock the catch lever and pull the magazine pusher back completely.
3. Remove the nail/staple stick from the magazine.
4. Loosen the cap screws shown in **Figure 7** and remove the cover with a 3mm hex wrench. Dislodge the jammed nail/staple with a pair of needle nose pliers.
5. Secure the cover with the cap screws removed in **Step 4**.

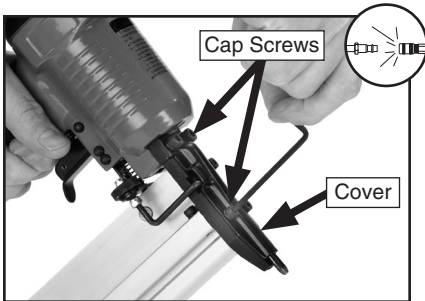
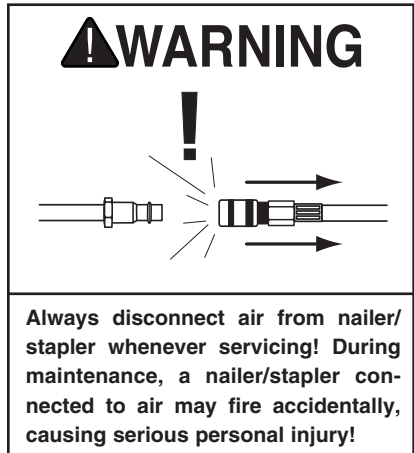

**Figure 7.** Opening cover to clear a jam.

6. Throw the damaged nail/staple away.
7. Inspect the nail/staple stick. If it is bent or damaged, throw it away and insert a new stick that only contains clean, undamaged nails/staples. **DO NOT** use dirty or damaged nails/staples!
8. Slide the magazine pusher forward to the front of the magazine until the catch lever locks.

## Replacing Pistons/O-Rings

If you use your nailer/stapler day in and day out, repair pistons are cheap insurance against wasted down time and lost profits, in the event that a piston or piston shaft becomes worn out. A replacement piston and O-ring kit, part PH7664084, may be purchased for the Model H7664.



To replace a piston and O-ring:

1. **DISCONNECT NAILER/STAPLER FROM THE AIR SUPPLY!**
2. Remove all nails/staples from the magazine.
3. Remove the four cap screws on the head of the nailer/stapler, near the exhaust port.
4. Remove the cap.
5. The top of the piston should now be visible inside the cylinder, which is housed in the head of the nailer/stapler.

6. Open the nose cover as if to clear a jammed nail/staple.
7. Watch the discharge area and push the top of the piston with your finger. You will see the piston shaft slide down the discharge area.
8. With a long flathead screwdriver or similarly shaped tool, push the piston shaft back inside the nailer/stapler until you can grip the piston head and remove it from the cylinder. (Be careful not to scratch the discharge area when pushing the piston shaft with the screwdriver.)
9. Place a new O-ring on the new piston and apply a thin film of the nailer/stapler lubricating oil on the O-ring.
10. Insert the new piston in the cylinder. Make sure that the grooves on the piston shaft line up with those on the guide at the bottom of the cylinder. The new piston should easily slide into the cylinder. **DO NOT force the piston into the cylinder!** If the piston is not easily inserted, double-check the alignment of the piston shaft with the grooves on the guide.
11. After the piston is inserted correctly, close the magazine pusher. Replace the rear cap assembly and tighten the 4 cap screws.
12. For more assistance, or to install a complete O-ring set, refer to the appropriate breakdown diagram in the back of this manual for component locations.



# SECTION 5: MAINTENANCE

## Cleaning

Disconnect the nailer/stapler from the air supply before cleaning. Use a good solvent to clean the nose assembly of the nailer/stapler. Always be sure that the nailer/stapler is dry before using it again.

Do not allow dust, chips, sand, etc. into the air connectors or into the body of the nailer/stapler; this may result in leaks and damage to the nailer/stapler and the air couplings.

**⚠ WARNING**



**Never use gasoline or other flammable liquids to clean this tool. Vapors in the tool may ignite, causing the tool to explode. Ignoring this warning may lead to serious personal injury or even death!**

## Lubricating

Pneumatic tool oil has been included with your new Grizzly nailer/stapler to help maintain its useful life. Place two to three drops of oil in the nailer/stapler air inlet (as shown in **Figure 8**) before every use, or after 2 hours of continuous use.

Wipe off any excess oil near the nailer/stapler exhaust to avoid dust build-up. When the oil that was included with the nailer/stapler has been completely used, replace with Grizzly Model G2820 Pneumatic Tool Oil.

Another option to manual oiling would be to install a lubricator in your air compressor line. If your air compressor line already has a lubricator, then regular lubrication of your nailer/stapler will not be necessary. Just make sure there is always oil in the lubricator.

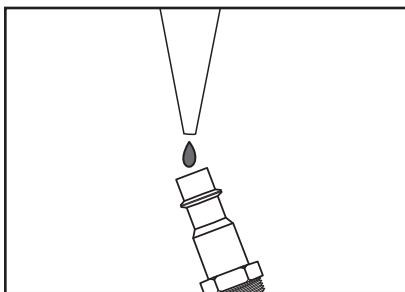
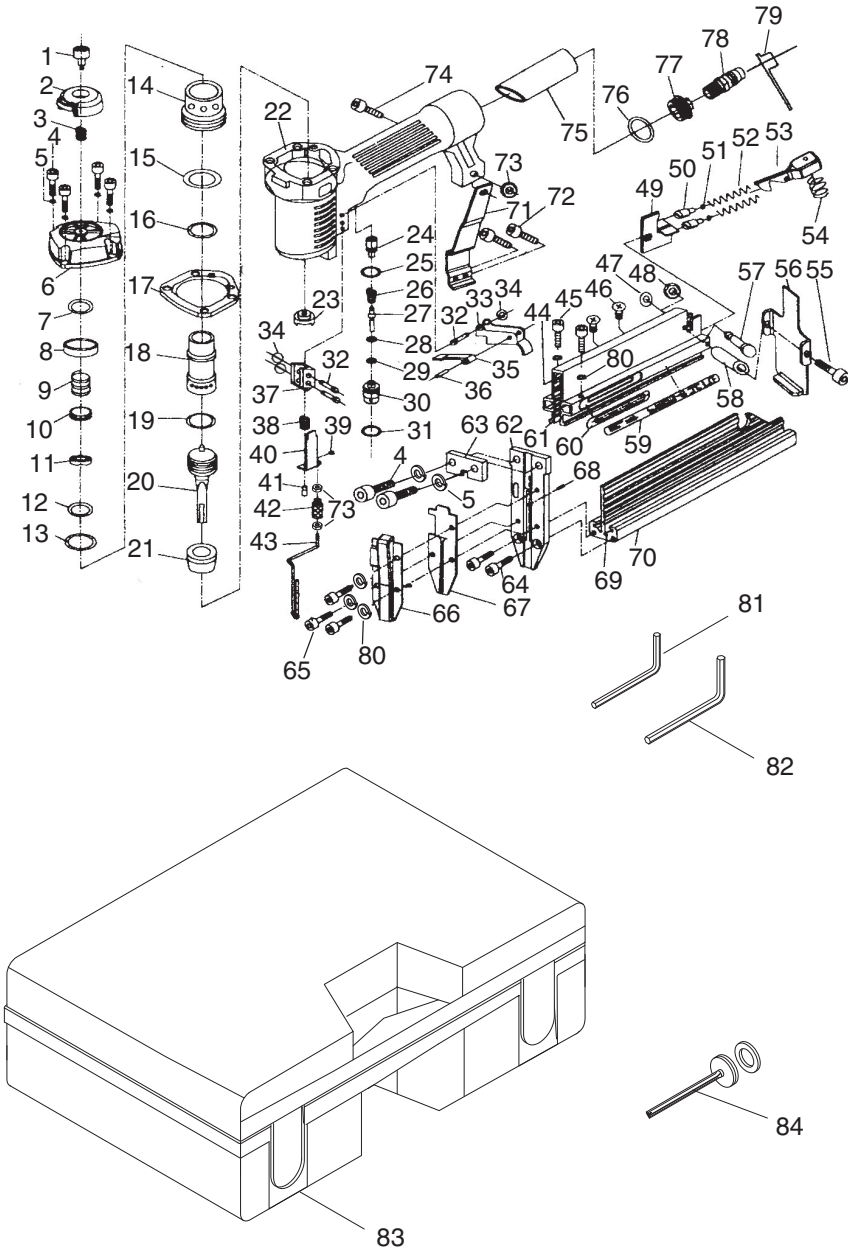

**Figure 8.** Lubricating nailer/stapler via air inlet.

## Troubleshooting

Symptom	Possible Cause	Solution
Air leaking at trigger valve area.	1. O-rings in trigger valve housing are damaged.	1. O-rings must be replaced & operation of safety yoke must be checked.
Air leaking between housing and hose.	1. Loose screws in housing. 2. Damaged O-ring. 3. Loose air fitting.	1. Tighten screws. 2. Replace O-ring. 3. Tighten air fitting & use teflon tape.
Air leaking between housing and cap assembly.	1. Damaged seal.	1. Replace damaged seals.
Tool skips fasteners while discharging.	1. Air leaks. 2. Dirt in nose. 3. Dirt or damage prevents fasteners from moving freely in magazine. 4. Inadequate air flow to tool.  5. Worn O-ring on piston or lack of lubrication. 6. Damaged O-rings on trigger valve. 7. Worn bumper. 8. Cap seal leaking.	1. Tighten screws and fittings. 2. Clean nose. 3. Clean magazine and inspect/repair damage.  4. Check fitting, hose, compressor & air pressure. 5. Replace piston O-ring. Lubricate. 6. Replace trigger valve O-rings. 7. Replace bumper. 8. Replace cap seal.
Tool runs slowly or has a loss of power.	1. Nailer/stapler is not sufficiently lubricated. 2. Broken spring in cap assembly. 3. Exhaust port in cap is blocked.	1. Lubricate nailer/stapler.  2. Replace spring.  3. Clean or replace damaged internal parts.
Fasteners frequently jam the nailer/stapler.	1. Fasteners are the wrong size. 2. Nailer/stapler is not sufficiently lubricated. 3. Fasteners are bent or dirty.  4. Magazine or nose screws are loose. 5. Driver or driver guide are worn or damaged.	1. Use correct nails/staples. 2. Lubricate nailer/stapler.  3. Use undamaged, clean fasteners. 4. Tighten magazine.  5. Replace worn or damaged parts.
Nailer/stapler does not fire.	1. Fastener is jammed in magazine or discharge area. 2. Piston shaft is damaged. 3. Air pressure too low.	1. Clear magazine or discharge area. 2. Replace piston shaft. 3. Check/increase air pressure.

# H7664 Parts Breakdown



# H7664 Parts List

REF	PART #	DESCRIPTION
1	PH7664001	SPCL CAP SCR M4-.7 X 20
2	PH7664002	AIR DEFLECTOR
3	PH7664003	COMPRESSION SPRING
4	PSB15M	CAP SCREW M5-.8 X 20
5	PLW01M	LOCK WASHER 5MM
6	PH7664006	CYLINDER COVER
7	PH7664007	O-RING 13 X 2.4
8	PH7664008	SEALING WASHER
9	PH7664009	COMPRESSION SPRING
10	PH7664010	ON/OFF VALVE
11	PH7664011	SEALING WASHER
12	PH7664012	O-RING 24.8 X 3.5
13	PH7664013	O-RING 31.2 X 2.5
14	PH7664014	COLLAR
15	PH7664015	O-RING 42.6 X 2.35
16	PH7664016	O-RING 30 X 1.8
17	PH7664017	SEALING GASKET
18	PH7664018	CYLINDER
19	PH7664019	O-RING 29.7 X 3.55
20	PH7664020	PISTON ASSEMBLY
21	PH7664021	BUMPER
22	PH7664022	BODY
23	PH7664023	GROMMET
24	PH7664024	PISTON VALVE
25	PH7664025	O-RING 11 X 1.2
26	PH7664026	COMPRESSION SPRING
27	PH7664027	VALVE STEM
28	PH7664028	O-RING 8 X 1
29	PH7664029	O-RING 1.9 X 1.1
30	PH7664030	TRIGGER VALVE GUIDE
31	PH7664031	O-RING 11.2 X 1.85
32	PH7664032	PIN 2.97 X 30
33	PH7664033	TRIGGER
34	PH7664034	O-RING 2.96 X 1.7
35	PH7664035	SAFETY PLATE
36	PRP12M	ROLL PIN 2.5 X 18
37	PH7664037	STAND
38	PH7664038	COMPRESSION SPRING
39	PEC12M	E-CLIP 12MM
40	PH7664040	STAND PLATE
41	PH7664041	RETAINER SNAP
42	PH7664042	ADJUSTING NUT

REF	PART #	DESCRIPTION
43	PH7664043	SAFETY YOKE
44	PH7664044	BAR
45	PSB23M	CAP SCREW M4-.7 X 12
46	PFH32M	FLAT HD SCR M4-.7 X 6
47	PH7664047	O-RING 2.4 X 1.8
48	PH7664048	PUSHER STICK
49	PH7664049	PUSHER
50	PH7664050	PUSHER STICK
51	PH7664051	O-RING 4.5 x 1.2
52	PH7664052	COMPRESSION SPRING
53	PH7664053	CATCH LEVER
54	PH7664054	COMPRESSION SPRING
55	PSB22M	CAP SCREW M4-.7 X 35
56	PH7664056	FIXED SEAT
57	PH7664057	PIN 3.93 X 15.50
58	PH7664058	PIPE
59	PH7664059	STICKER PLATE
60	PH7664060	SCALE
61	PH7664061	SLIDING MAGAZINE
62	PH7664062	NOSE
63	PH7664063	SPACER
64	PSB41M	CAP SCREW M4-.7 X 14
65	PSB17M	CAP SCREW M4-.7 X 10
66	PH7664066	NOSE COVER
67	PH7664067	DRIVER GUIDE
68	PH7664068	PIN 1.5 X 12
69	PH7664069	INLAY SLICE
70	PH7664070	MAGAZINE
71	PH7664071	FIXED SEAT
72	PSB18M	CAP SCREW M4-.7 X 8
73	PN04M	HEX NUT M4-.7
74	PSB16M	CAP SCREW M4-.7 X 16
75	PH7664075	RUBBER HANDLE CASE
76	PH7664076	O-RING 36.3 X 3.55
77	PH7664077	END CAP
78	PH7664078	1/4" NPT MALE CONNECT
79	PH7664079	AIR PLUG COVER
80	PLW02M	LOCK WASHER 4MM
81	PAW03M	HEX WRENCH 3MM
82	PAW04M	HEX WRENCH 4MM
83	PH7664083	CARRYING CASE
84	PH7664084	PISTON REPAIR KIT

# WARRANTY AND RETURNS

---

Grizzly Industrial, Inc. warrants every product it sells for a period of **1 year** to the original purchaser from the date of purchase. This warranty does not apply to defects due directly or indirectly to misuse, abuse, negligence, accidents, repairs or alterations or lack of maintenance. This is Grizzly's sole written warranty and any and all warranties that may be implied by law, including any merchantability or fitness, for any particular purpose, are hereby limited to the duration of this written warranty. We do not warrant or represent that the merchandise complies with the provisions of any law or acts unless the manufacturer so warrants. In no event shall Grizzly's liability under this warranty exceed the purchase price paid for the product and any legal actions brought against Grizzly shall be tried in the State of Washington, County of Whatcom.

We shall in no event be liable for death, injuries to persons or property or for incidental, contingent, special, or consequential damages arising from the use of our products.

To take advantage of this warranty, contact us by mail or phone and give us all the details. We will then issue you a "Return Authorization Number," which must be clearly posted on the outside as well as the inside of the carton. We will not accept any item back without this number. Proof of purchase must accompany the merchandise.

The manufacturers reserve the right to change specifications at any time because they constantly strive to achieve better quality equipment. We make every effort to ensure that our products meet high quality and durability standards and we hope you never need to use this warranty.

Please feel free to write or call us if you have any questions about the machine or the manual.

**Grizzly Industrial, Inc.**  
**1203 Lycoming Mall Circle**  
**Muncy, PA 17756**  
**Phone: (570) 546-9663**  
**Fax: (800) 438-5901**

**E-Mail:**  
**techsupport@grizzly.com**

**Web Site: <http://www.grizzly.com>**

Thank you again for your business and continued support. We hope to serve you again soon!





# WARRANTY CARD

Name \_\_\_\_\_

Street \_\_\_\_\_

City \_\_\_\_\_ State \_\_\_\_\_ Zip \_\_\_\_\_

Phone # \_\_\_\_\_ Email \_\_\_\_\_ Invoice # \_\_\_\_\_

Model # \_\_\_\_\_ Order # \_\_\_\_\_ Serial # \_\_\_\_\_

*The following information is given on a voluntary basis. It will be used for marketing purposes to help us develop better products and services. **All information is strictly confidential.***

**1. How did you learn about us?**

Advertisement     Friend     Catalog  
 Card Deck     Website    Other: \_\_\_\_\_

**2. Which of the following magazines do you subscribe to?**

Cabinet Maker     Popular Mechanics     Today's Homeowner  
 Family Handyman     Popular Science     Wood  
 Hand Loader     Popular Woodworking     Wooden Boat  
 Handy     Practical Homeowner     Woodshop News  
 Home Shop Machinist     Precision Shooter     Woodsmith  
 Journal of Light Cont.     Projects in Metal     Woodwork  
 Live Steam     RC Modeler     Woodworker West  
 Model Airplane News     Rifle     Woodworker's Journal  
 Modeltec     Shop Notes     Other:  
 Old House Journal     Shotgun News

**3. What is your annual household income?**

\$20,000-\$29,000     \$30,000-\$39,000     \$40,000-\$49,000  
 \$50,000-\$59,000     \$60,000-\$69,000     \$70,000+

**4. What is your age group?**

20-29     30-39     40-49  
 50-59     60-69     70+

**5. How long have you been a woodworker/metalworker?**

0-2 Years     2-8 Years     8-20 Years     20+ Years

**6. How many of your machines or tools are Grizzly?**

0-2     3-5     6-9     10+

**7. Do you think your machine represents a good value?**     Yes     No

**8. Would you recommend Grizzly Industrial to a friend?**     Yes     No

**9. Would you allow us to use your name as a reference for our customers in your area?**

Note: *We never use names more than 3 times.*     Yes     No

**10. Comments:** \_\_\_\_\_

\_\_\_\_\_

\_\_\_\_\_

\_\_\_\_\_

Send a Grizzly Catalog to a friend:

Name _____
Street _____
City _____ State _____ Zip _____

FOLD ALONG DOTTED LINE

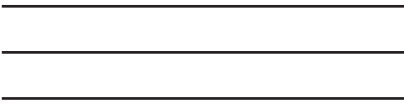

Place  
Stamp  
Here



GRIZZLY INDUSTRIAL, INC.  
P.O. BOX 2069  
BELLINGHAM, WA 98227-2069



TAPE ALONG EDGES--PLEASE DO NOT STAPLE